

Kawasaki Rose

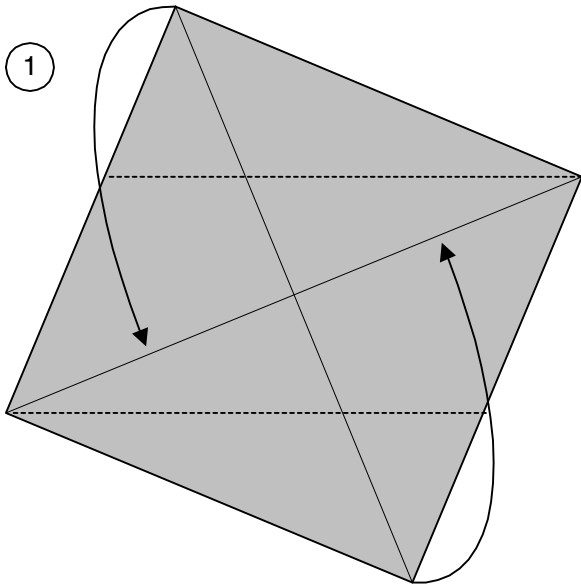

Folding the rose begins with creating a grid on the paper at a 22.5 degree angle, 45 degree/2. Crease diagonals, and with the coloured side up, valley fold left side to the diagonal. Repeat above. It is important to fold the correct side to the diagonal, as shown in the diagram.

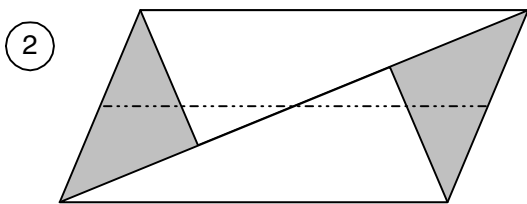

Mountain fold only the bottom layer

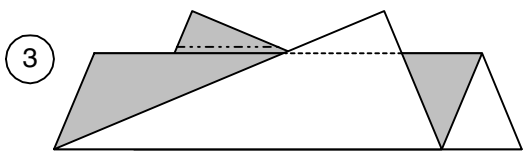

Valley fold the tip of the front layer so that it is flush with the layer behind. Repeat behind.

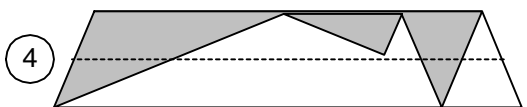

Valley fold/unfold first two layers of paper. Repeat behind

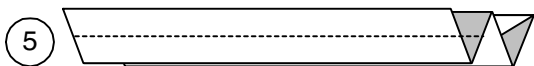

Valley fold/unfold first four layers of paper. I recommend that the folder fold at most two layers of paper at a time to avoid paper drift. The type of fold (valley or mountain) is unimportant at this point in folding

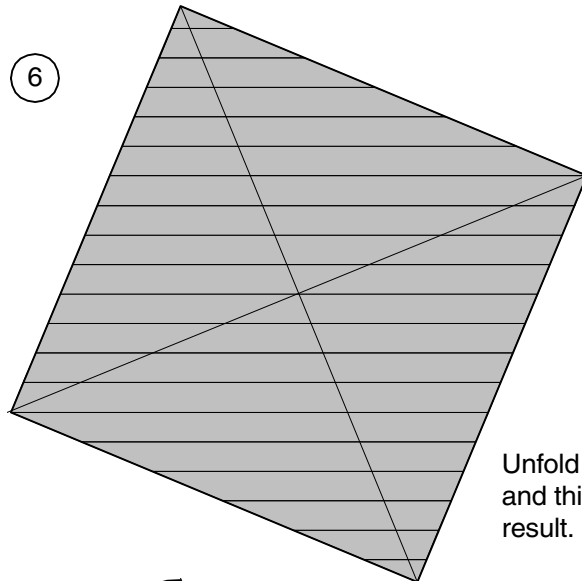

Unfold steps 1 to 4 and this is the result.

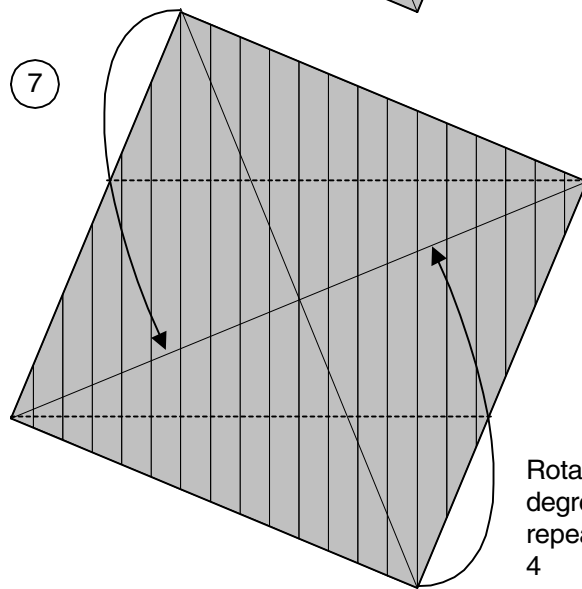

Rotate 90 degrees and repeat steps 1 to 4

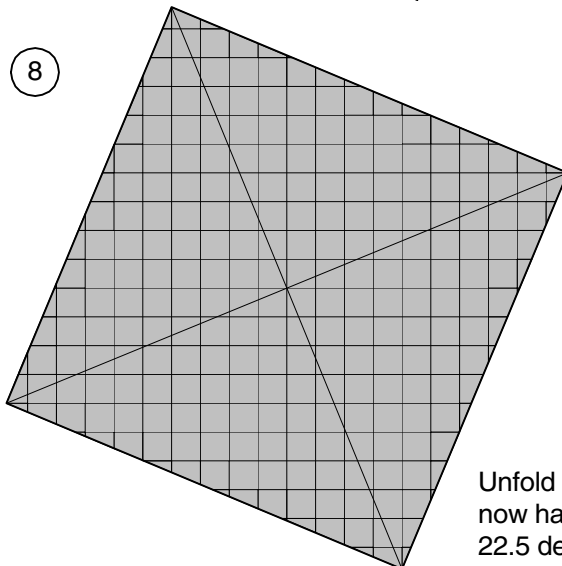

Unfold and you should now have a grid on a 22.5 degree angle.

Kawasaki Rose	1/5
Designer: Toshikazu Kawasaki	
Diagrammed By: Winson Chan	
Revision: 2.1	Date: 4/29/96

9

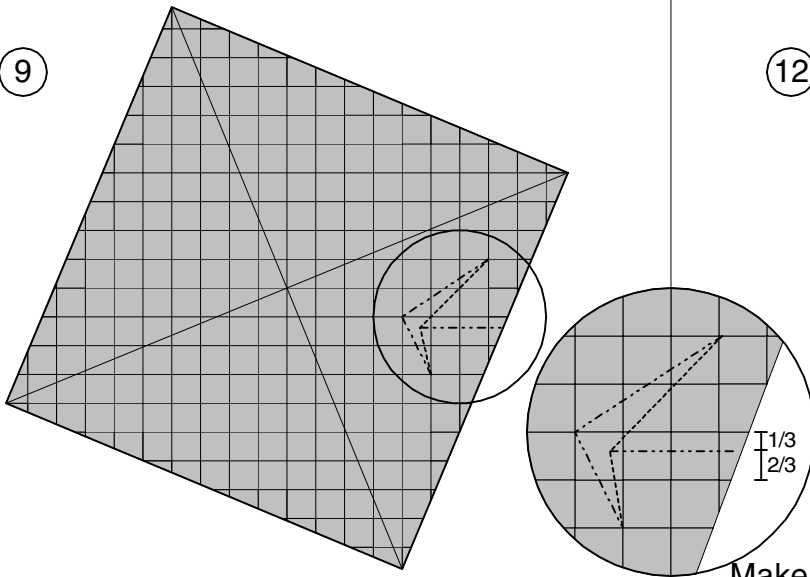

Make the following mountain and valley folds. See enlargement. Notice the position of the horizontal crease. Repeat on all four sides

10

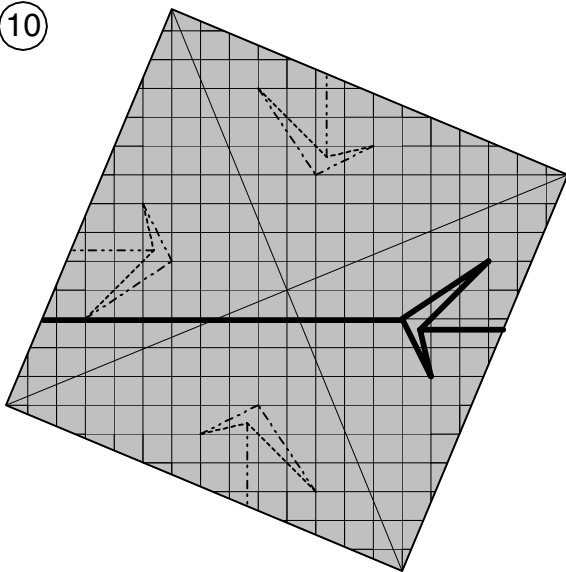

The paper should look like this after completing each set. Reinforce each set of folds by crimping along the darkened line.

11

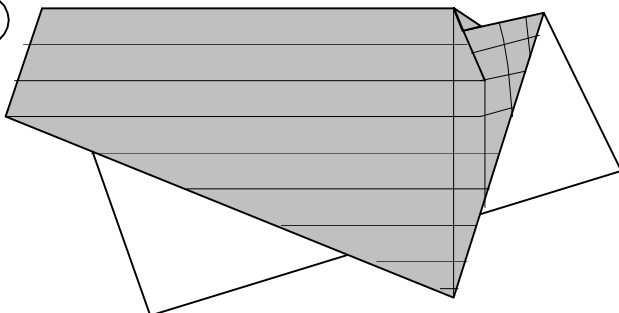

This is what one of the crimps looks like. Repeat on all four sets.

12

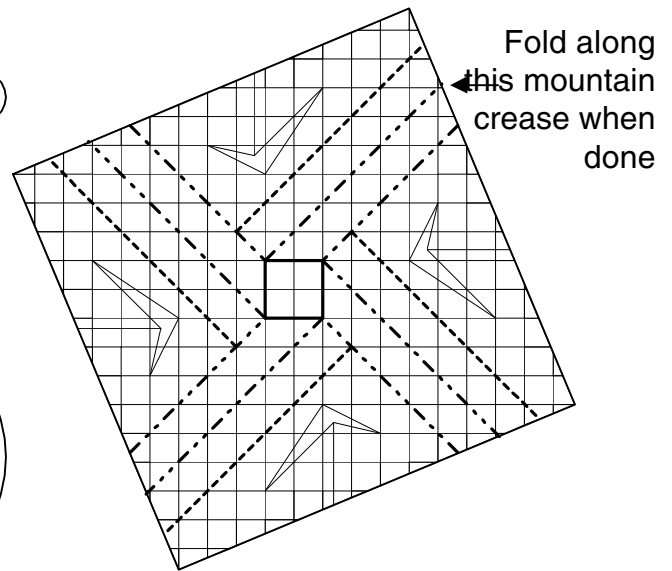

Make the following mountain and valley folds. They are at 45 degrees relative to the grid. The square in the centre can be used as a guide. When these creases are complete, mountain fold along the crease indicated, the entire length of the paper

13

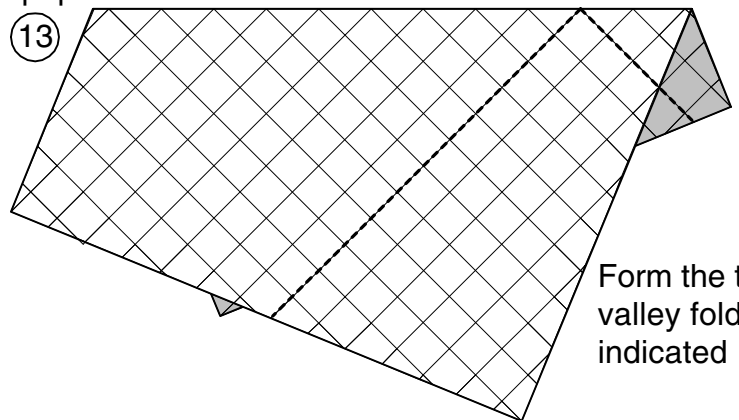

Form the two valley folds indicated

14

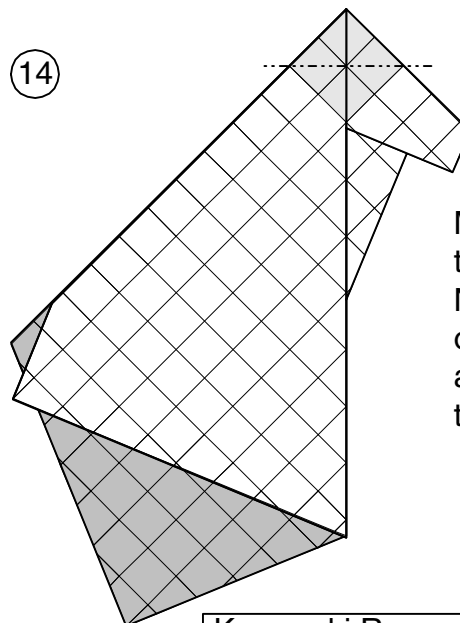

Mountain fold the top point behind. Notice the location of the light gray area over the next three steps.

15

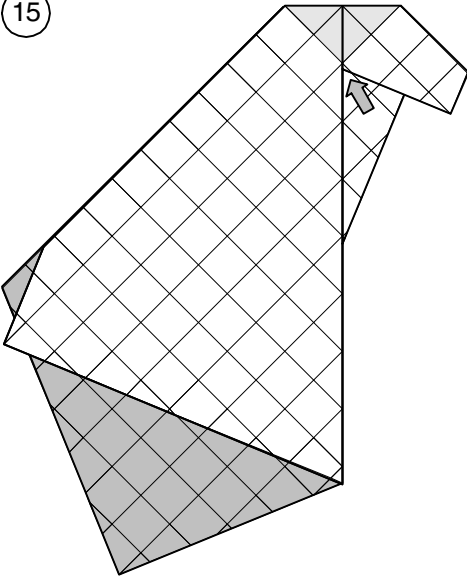

Open up the model by inserting a finger into the section indicated. Model will not remain flat. Notice the movement of the light gray section

16

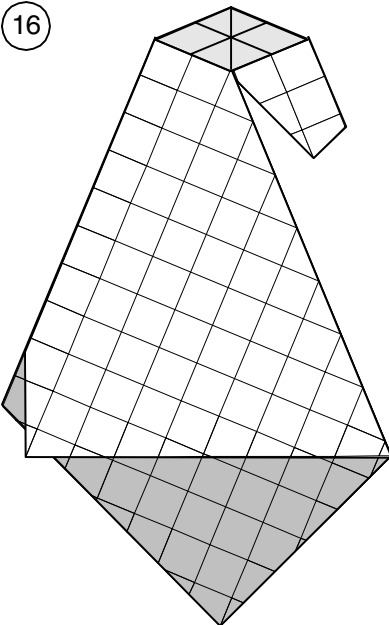

Unfold model to step 12.

17

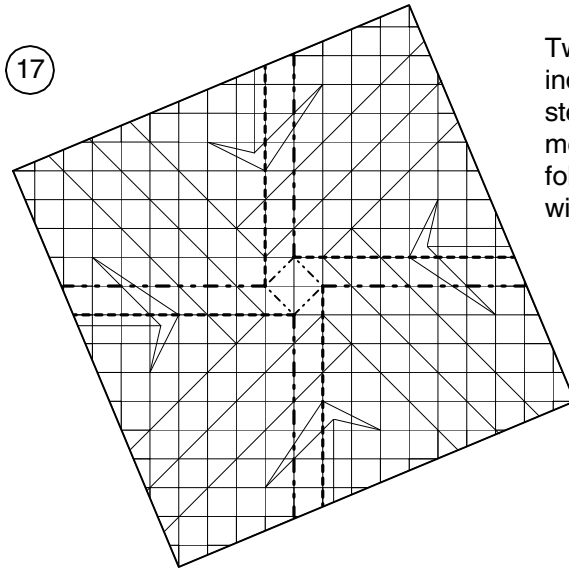

Twist fold along the lines indicated. The next 2 steps provide a simple method of doing a twist fold if you are not familiar with it.

18

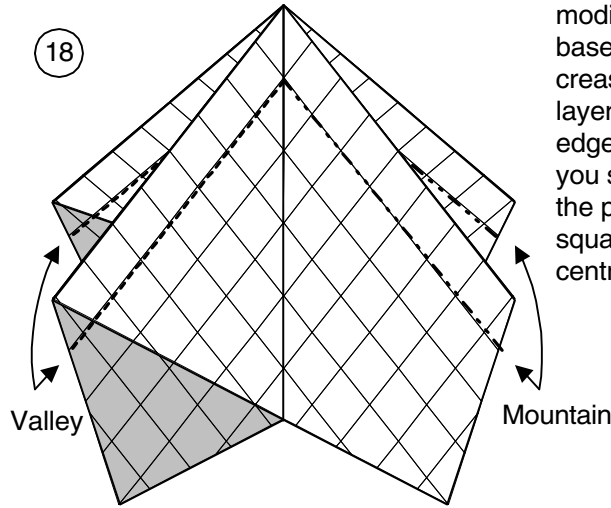

Form a (slightly modified) waterbomb base along existing creases. Fold both layers of paper on each edge as indicated, while you spread out/ flatten the paper. Carefully squash the paper in the centre into a square.

19

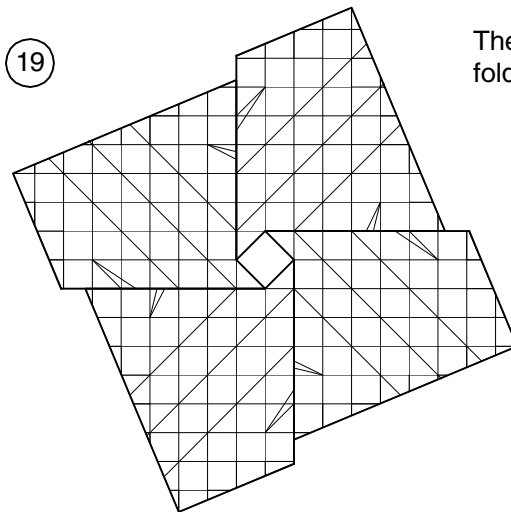

The model after the twist fold. Flip paper over.

20

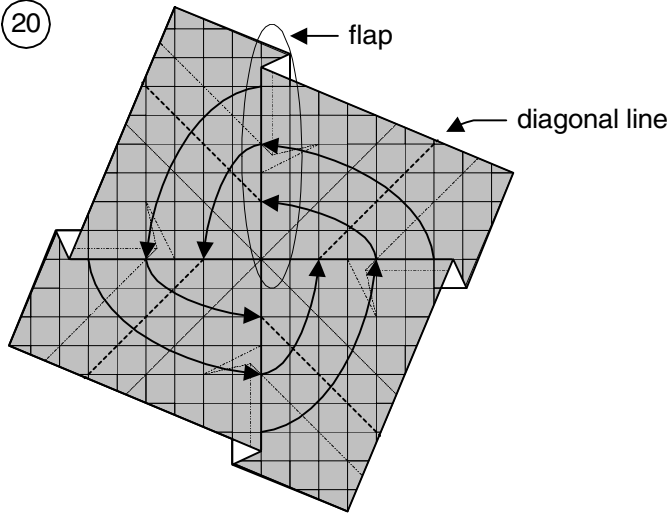

Bring together the flaps formed by the twist fold. Valley fold along the diagonal line to help with this. Model will not remain flat, and should resemble a cylinder. Make sure that the centre points up, not down.

21

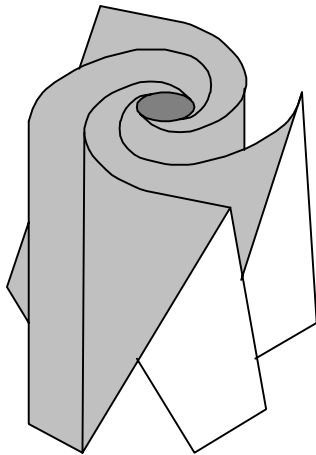

To create the cylinder like appearance of the model, place one hand around the model, insert one finger (of the other hand) and rotate finger clockwise. Be careful not to make break the paper. The model will wrap tightly around your finger. This step will improve the look of the model and is not essential.

22

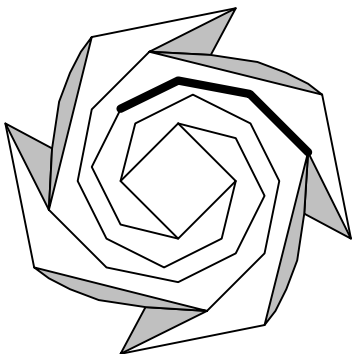

View from the bottom of the rose before the reverse folds. Notice the movement of the darkened line. See step 25.

23

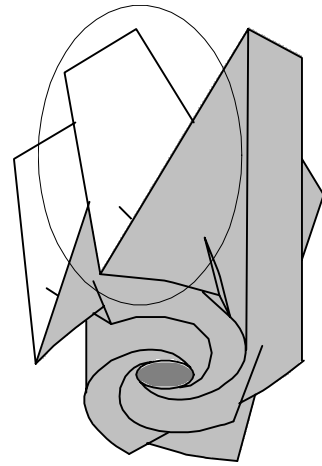

Re-form the crimps in step 11. Turn the model upside down. Notice the enlargement of the indicated area in the next step. The next few steps will consist of re-forming the folds in steps 13 to 16. This will lock the base of the rose.

24

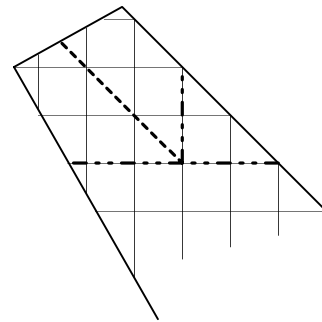

Enlargement of the indicated area in the previous step. No new creases are needed. All creases were folded in correct direction (mountain or valley) in steps 13 to 16. Make sure to fold both layers of paper. The folder should realize this fold is essentially a reverse fold. A review of a reverse fold is found on page 5.

25

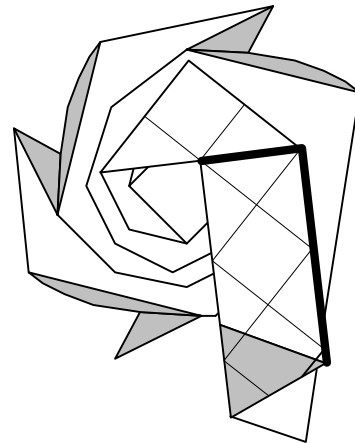

This is what the model looks like. Notice the darkened line, and compare it with the diagram in step 22. Repeat this with all 4 flaps.

Kawasaki Rose	4/5
Designer: Toshikazu Kawasaki	
Diagrammed By: Winson Chan	
Revision: 2.1	Date: 4/29/96

26

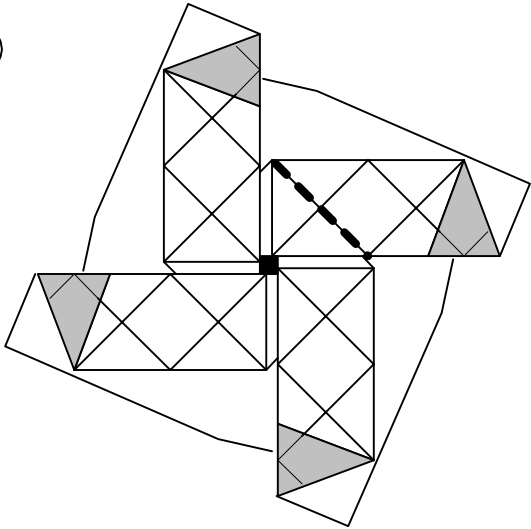

This is what the model looks like after the inside reverse fold on each flap. It is essential that the hole in the centre is as small as possible. Try pulling on the flaps to reduce the size of the hole. Next, do an outside reverse fold (on the two layers) so that it wraps back around the model.

27

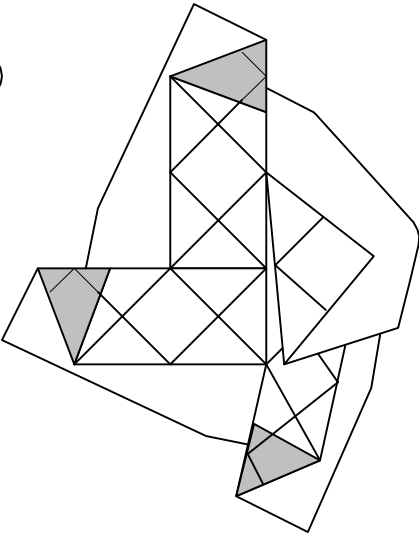

This is what the model looks like after one outside reverse fold. Notice how we have now refolded steps 13 to 16. Now do the same on the remaining 3 flaps so that the four flaps overlap each other. The last fold is the most difficult.

28

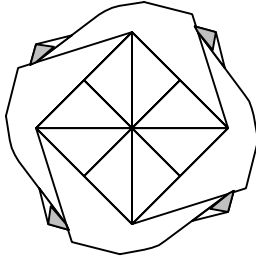

The underside of the completed rose. The rose is now essentially done. Flip the rose over, reform the centre by inserting a finger and rotating it clockwise as in step XX. Form petals into desired shape. The rose is now complete

29

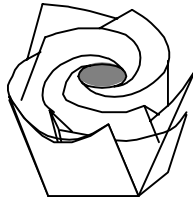

A very poor drawing of the top of the rose. I'll fix it in my next revision!

Have Fun!

The Kawasaki Rose was taught to me (the diagrammer) by Joseph Wu, who was taught by Toshikazu Kawasaki at the Convention in New York in 1994.

You can make copies of these diagrams for personal use and for friends, but do not make large number of copies for wide distribution (i.e. at a Convention).© 1996

Inside Reverse Fold

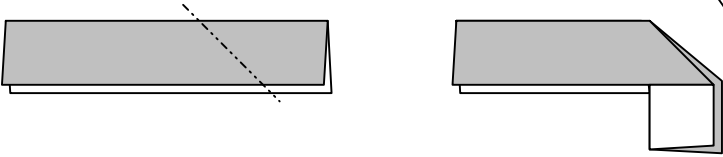

Outside Reverse Fold

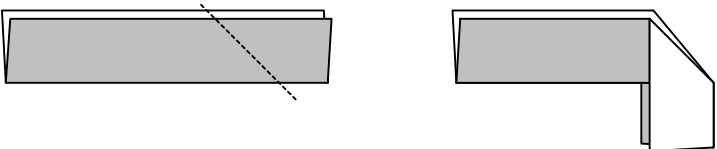

Kawasaki Rose	5/5
Designer: Toshikazu Kawasaki	
Diagrammed By: Winson Chan	
Revision: 2.1	Date: 4/29/96